



Name: _____

Date: _____

Mark each drawing as follows:

If you would do the job like in the picture, put a  on it.

If you would not do the job like in the picture, put a  on it.

When you finish, there should be only one  and two  on each page.

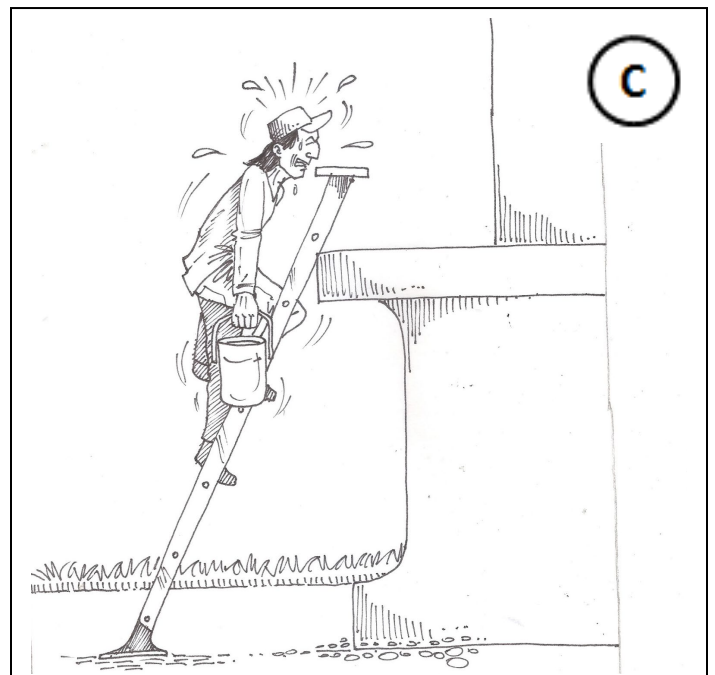
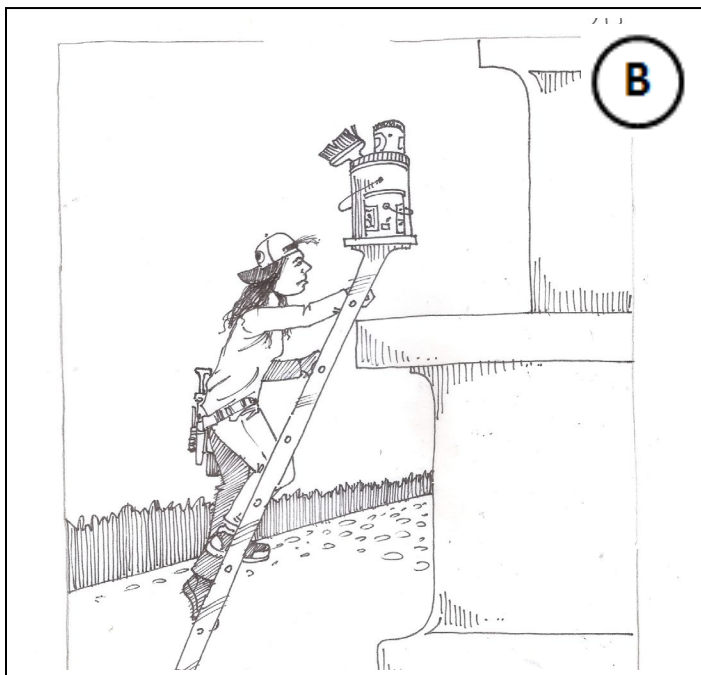
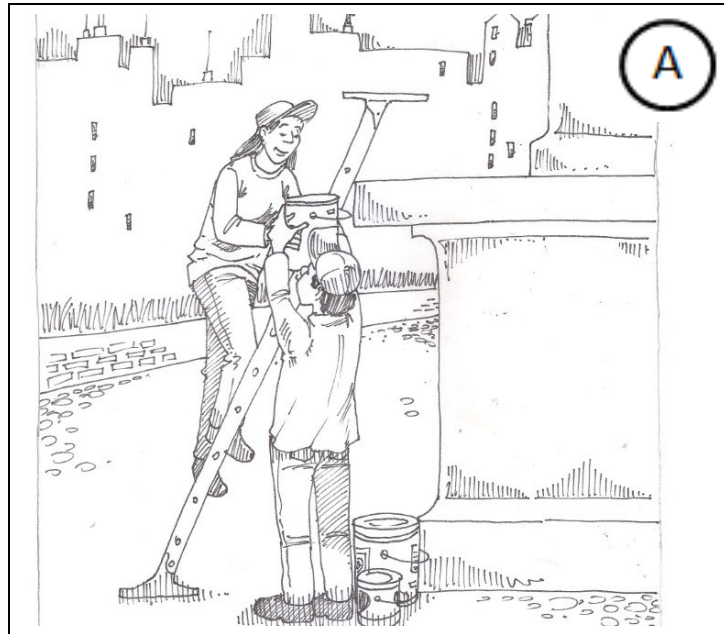

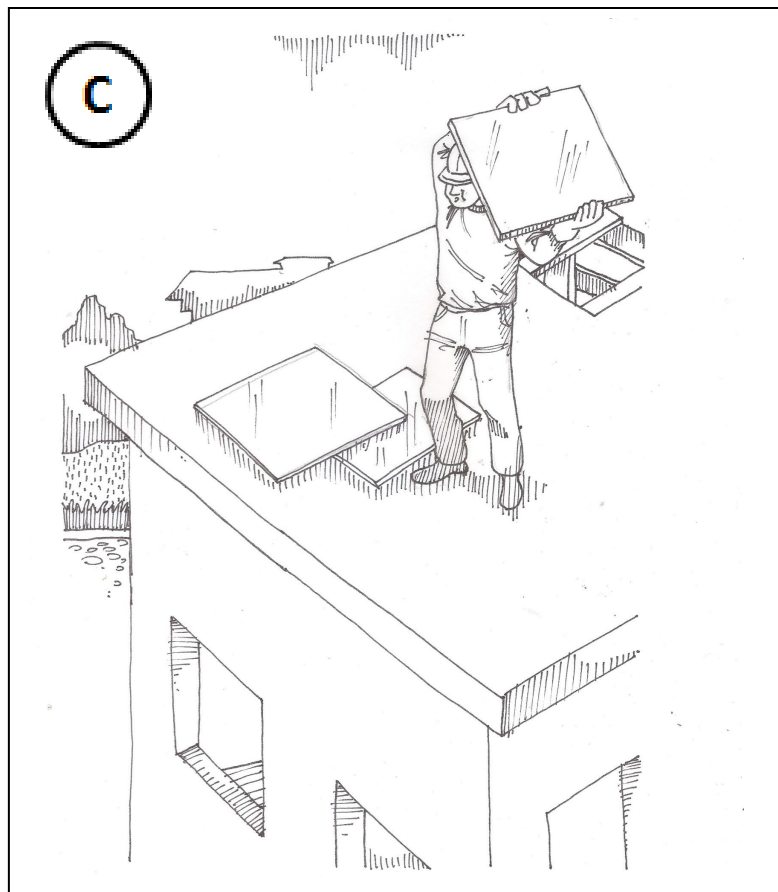
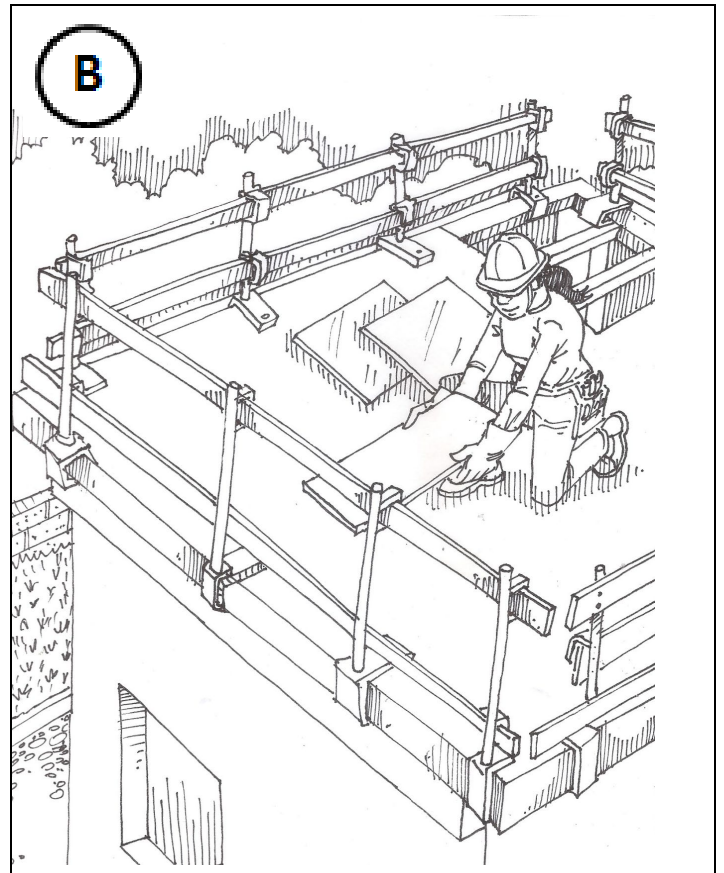
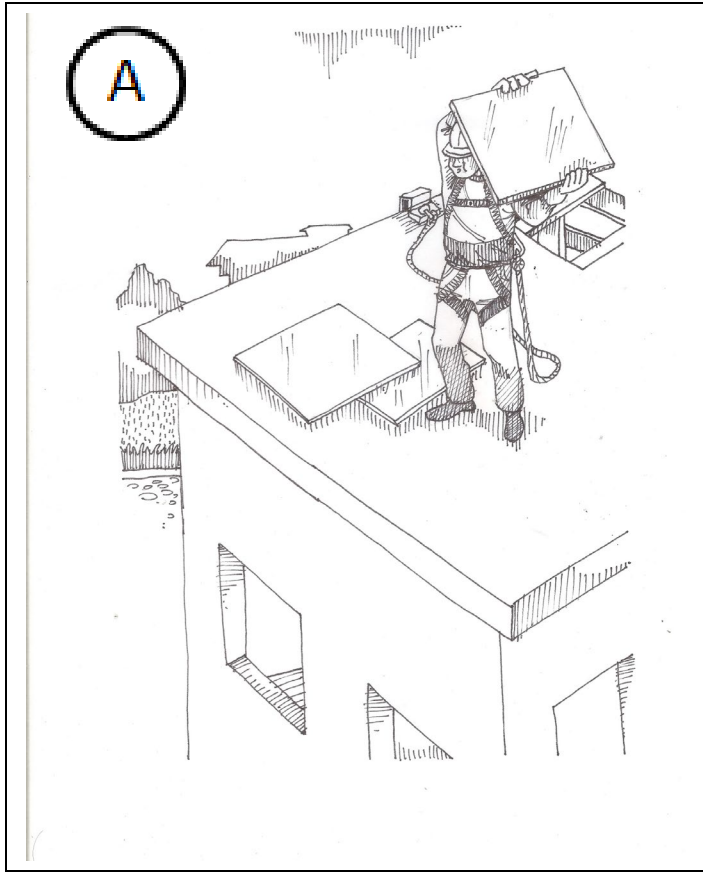

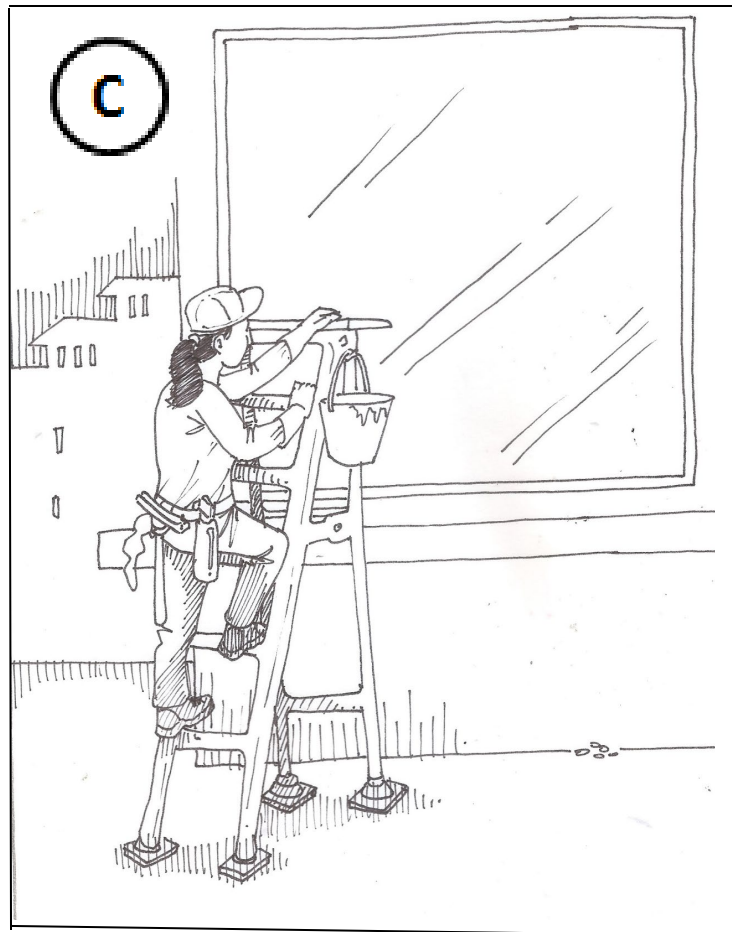
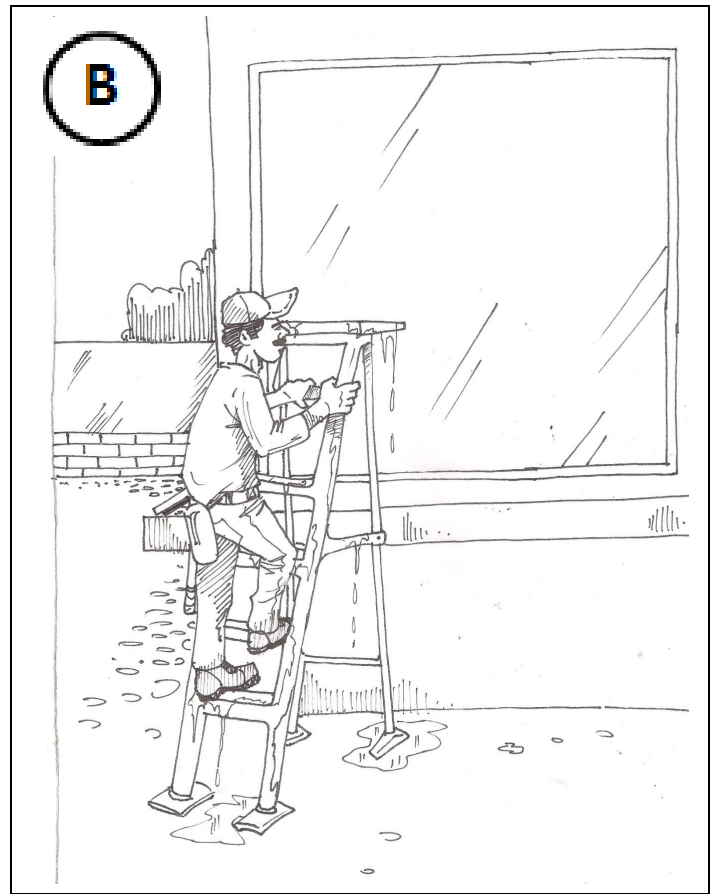
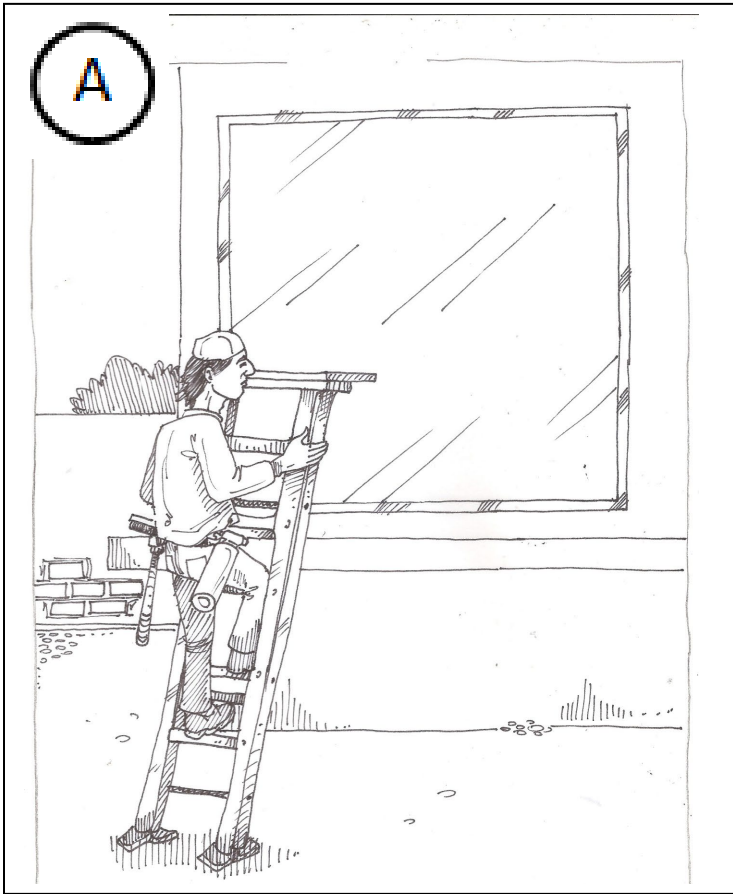

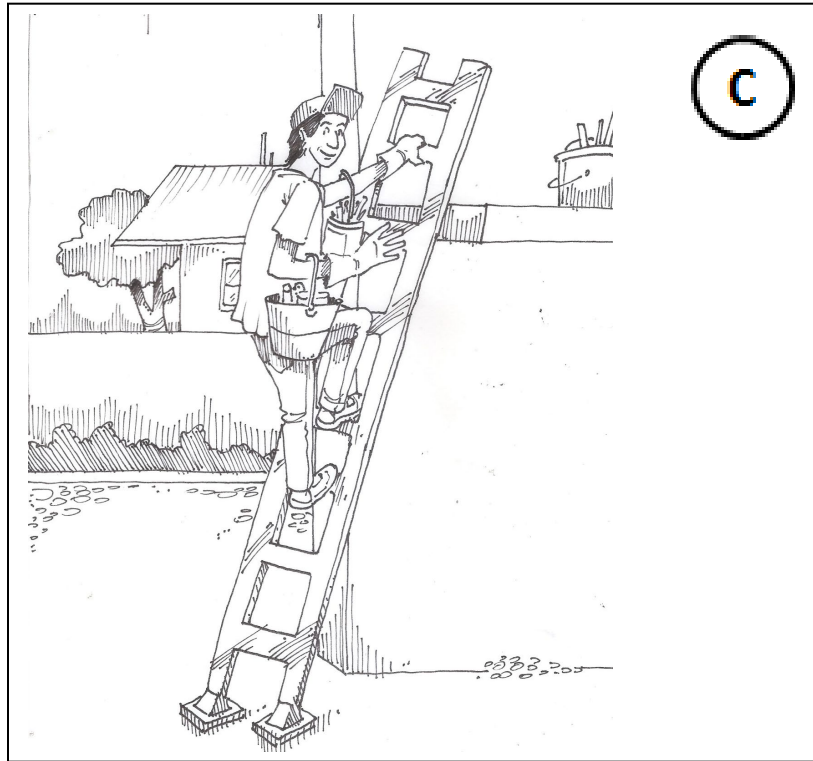
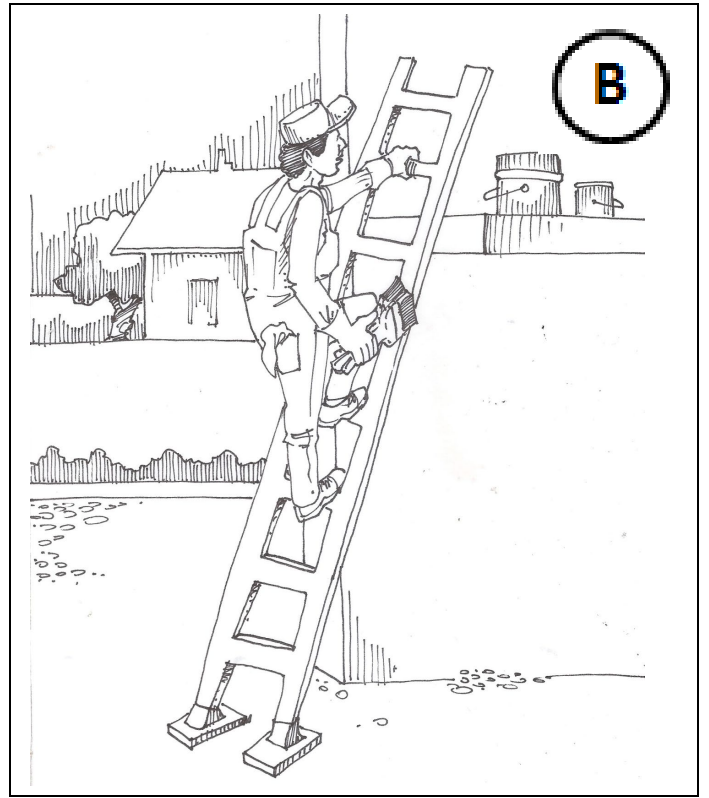
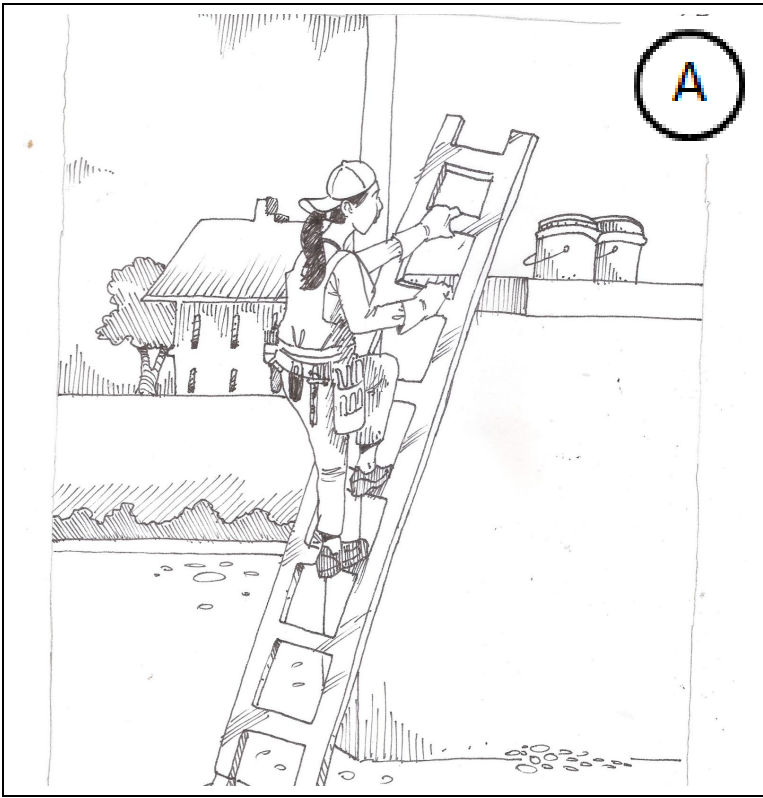

This material was produced under the Susan Harwood Grant # SH-31247-SH7 of the U.S. Department of Labor's Occupational Health and Safety Administration. It does not necessarily reflect the viewpoints or politics of the U.S. Department of Labor, nor do mentions of trademarks, commercial products, or organizations imply U.S. government endorsement. The U.S. government does not warrant or assume any legal responsibility and is not responsible for the accuracy, integrity, or usefulness of any disclosed information, equipment, product, or process.

ANSWERS

A

B

C

A